



**ADVANCED CONDITION
MONITORING AND
PROTECTION FOR
STEAM TURBINE
APPLICATIONS**

vibro-meter

Parker MEGGITT

VIBRO-METER SENSOR PORTFOLIO

for Steam Turbine Applications

vibro-meter's full range of vibration, displacement and rotor motion sensors can be used with our monitoring system hardware and software, or third-party systems, to provide complete solutions for the monitoring and protection of steam turbines and processes. From standard to industrial environments, including hazardous areas and/or extreme temperatures.

Moving-Coil Velocity Sensors **A**

Our CV21x and VE210 moving-coil velocity sensors have the advantages of being self-powered and providing a strong output signal in native velocity units (mm/s), so the signal-to-noise ratio is excellent, and no integration is required.



Accelerometers with External Electronics **A**

The CA series of sensors are high-temperature, piezoelectric-based accelerometers designed for the long-term measurement and monitoring of absolute vibration in the most severe of environments (up to 700°C).

Accelerometers with Integrated Electronics **A**

The CE series of sensors are piezoelectric-based accelerometers that come with either attached electronics for higher temperature applications (up to 350°C) or integrated electronics for lower temperature applications (up to 120°C). These sensors are suitable for the vibration monitoring in steam turbines, compressors, pumps, and fans.

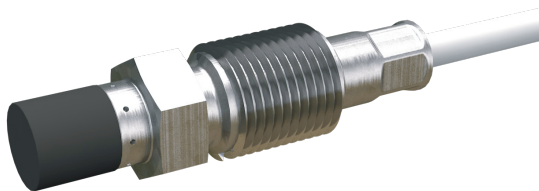

Proximity probes **SR** **Z** **Φ** **ZS** **DE** **E**

The TQ series covers a broad measurement range from 2 to 12 mm and are designed to withstand pressures up to 100 bar from speed and vibration to large-displacement expansion measurement using pendulum probes.

Housing expansion LVDTs **CE**

The AE119 housing expansion probes use LVDTs for the measurement of casing expansion on the high-pressure end/side of large steam turbines.



SOLUTION PORTFOLIO

Plant-Wide Ecosystems Integration

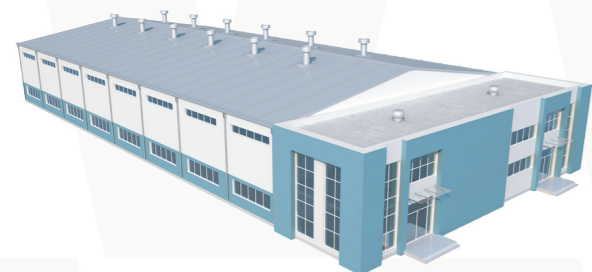

← SECURE REMOTE CONNECTION

Local or Remote Monitoring Center

Capability to safely transfer acquired data in quasi real-time through a data diode to a remote monitoring center for data analysis and archiving (VibroSight).



VibroSight

As a common data visualization, event management and diagnostic software platform, VibroSight allows plant operators to choose the system or combination of systems that meets the requirements of any given plant.



Plant Control System

Capability to communicate with third-party systems such as a DCS or PLC via industry standard protocols like Modbus, Profibus or IEC 61850 GOOSE, or via relays.

ETHERNET

FIELDBUS

SENSOR SIGNALS



VM600^{MK2}

Centralized and modular architecture with a higher channel density that addresses complex installations. Dynamic inputs and auxiliary inputs (tacho, process, other) from proximity probes, accelerometers, and velocity sensors are connected to cards installed into standard 19-inch, 6U racks installed in a cabinet. 1U racks are also available.

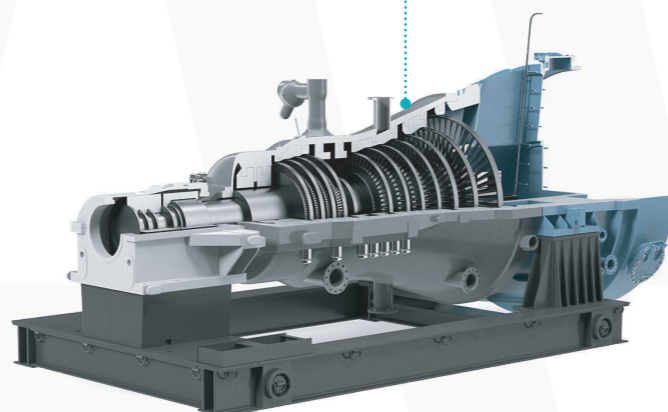

Steam Turbine

The measurement chain starts with vibro-meter's high reliability, high sensitivity dynamic accelerometers and proximity sensors which can survive indefinitely within harsh environments, plant operators can monitor virtually every parameter necessary to provide detailed information on equipment condition.

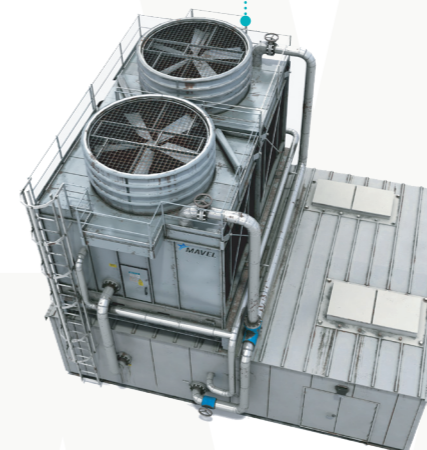

BOP

Our distributed monitoring system pioneering architecture is an ideal solution to the dispersed nature of balance-of-plant equipment without compromising the protection and monitoring of the critical machinery.

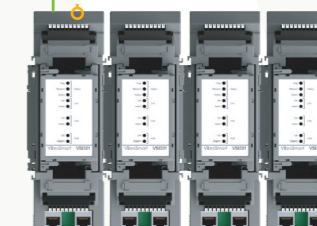

VibroSmart

Distributed architecture with a lower channel density. Inputs from all measurement chains are wired to DIN-rail mounted modules typically installed in an industrial housing, closer to or on the machinery being monitored. As a result, sensor cabling is effectively replaced by Ethernet cabling, thereby reducing installation costs.

vibro-meter solutions are engineered to ensure you get the most from your critical machines.

W VIBRO-METER MEASUREMENT COVERAGE

for Steam Turbine Applications

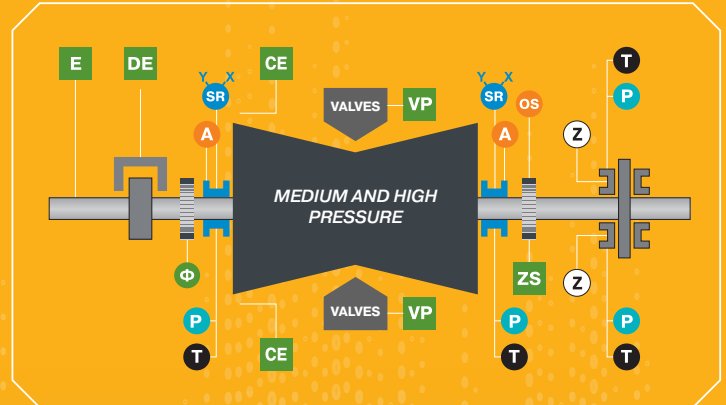

MEDIUM AND HIGH PRESSURE TURBINE

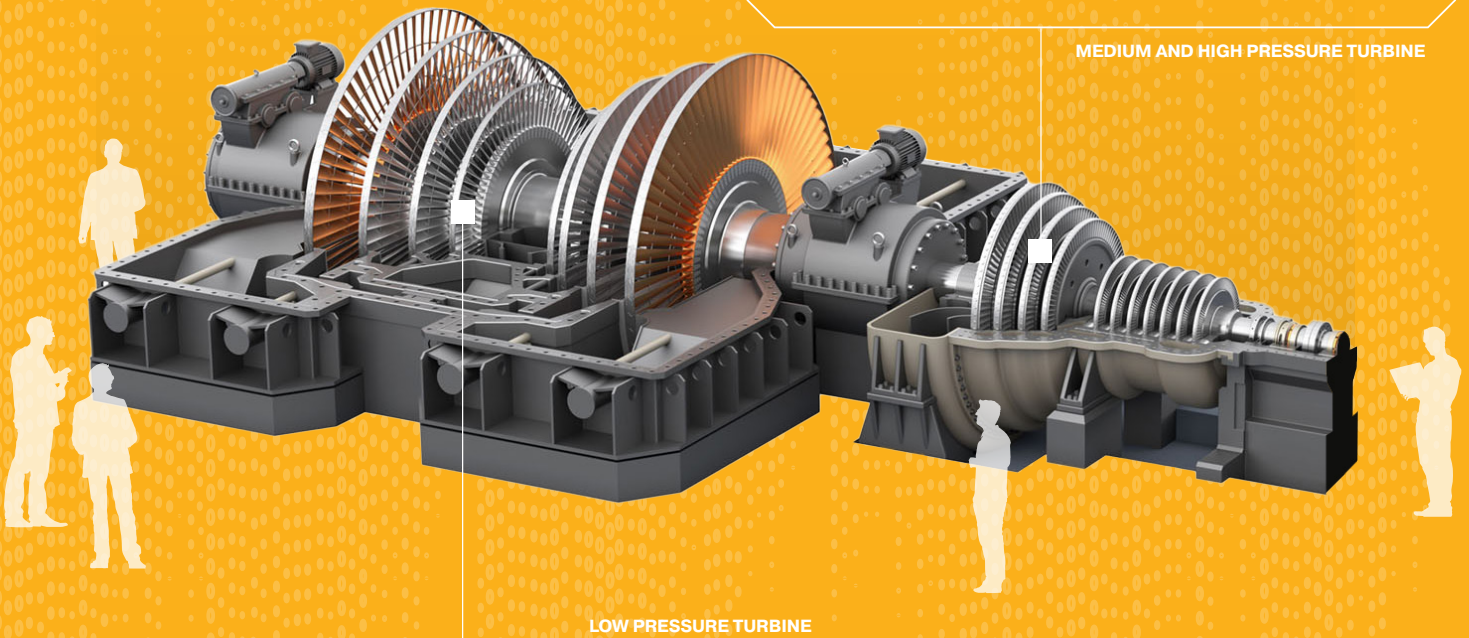

LOW PRESSURE TURBINE

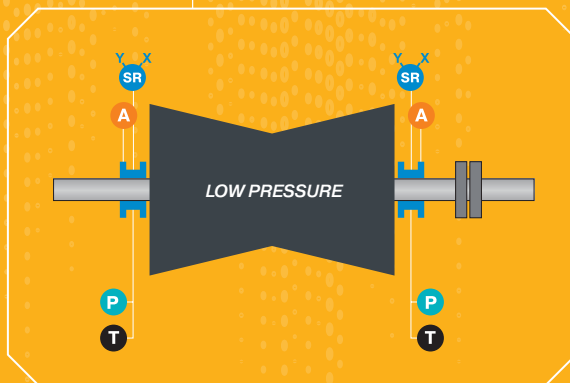

Measurements

A Absolute Vibration

Z Thrust/Axial Position

OS Overspeed

E Eccentricity

P Lube Oil Pressure

Φ Speed/Phase Ref

ZS Zero Speed

DE Differential Expansion

T Bearing Temp

SR Shaft Relative Vibration

VP Valve Position

CE Case Expansion

TSI-Specific Measurements

Conventional Measurements

WHY VIBRO-METER?

From sensors covering every steam turbine mechanical measurement to machinery monitoring and protection systems with powerful condition monitoring software, vibro-meter solutions are engineered to ensure you get the most from your steam turbines, whether it's a 150-kW single-stage unit in mechanical drive service or a 1800 MW compound unit used for power generation.

We also offer a broad portfolio of supporting services delivered by our experienced partners.



VM



HIGHLIGHTS

for Steam Turbine Applications

- Sensors designed to operate with higher reliability and meantime before failure (MTBF) in extreme environments; technology directly derived from our onboard aircraft equipment.
- Centralized (VM600) and distributed (VibroSmart) machinery protection and condition monitoring solutions.
- More than 10,000 VM600 systems and over 100,000 TQ proximity measurement chains installed world-wide.
- SIL rated systems that comply with IEC 61508 standards and API 670 5th edition.
- Integrated and cybersecure as per IEC 62443 standards.
- VibroSight software package offers extensive options for monitoring and analysing vibration data contributing to condition-based maintenance, which increases the service life and uptime of the machine.
- Customised configuration of the system and turnkey solutions through vibro-meter's sales network, including cabinets.



Enabling Engineering **Breakthroughs**

Learn more about
Steam Turbine Monitoring Solutions

